

RWS-180012

Workshop on 3GPP Submission Towards IMT-2020

24-25 October 2018

Brussels, Belgium



3GPP's Low-Power Wide-Area IoT Solutions: NB-IoT and eMTC

Low-power wide-area IoT

Connection density

1 000 000
UEs/km²

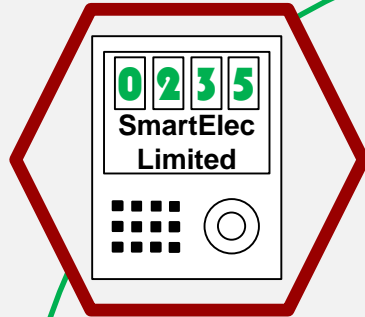

UE battery life

10 – 15 years in
164 dB MCL

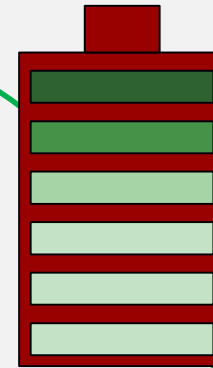

Four KPIs for 3GPP LPWA IoT solutions

Coverage extension

164 dB MCL
@ 160 bps

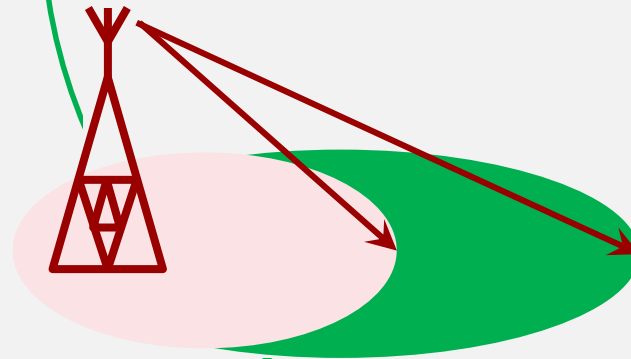

UE complexity and cost

Ultra-low

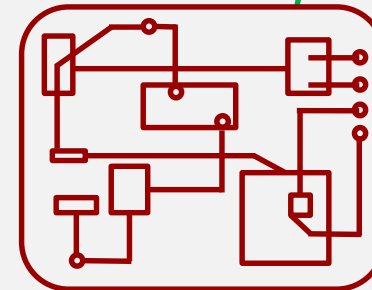

NB-IoT and eMTC project timelines

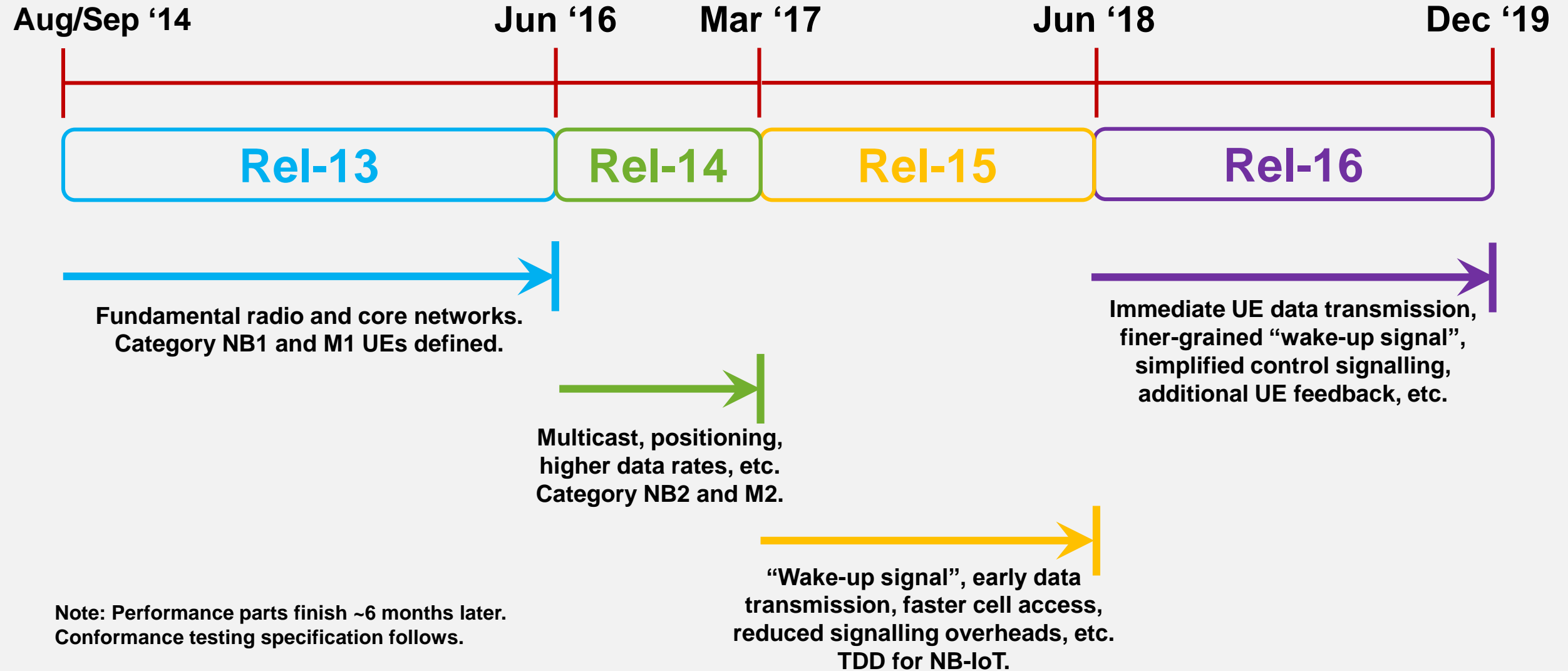

mMTC connection density

NB-IoT

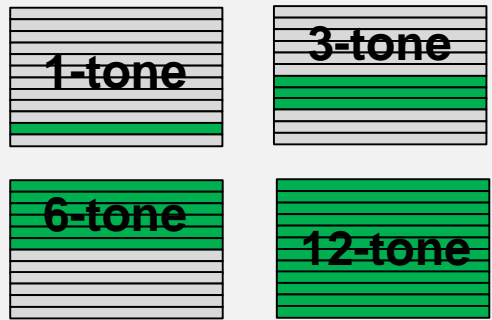

Single-tone and 3/6/12-tone UL allocations

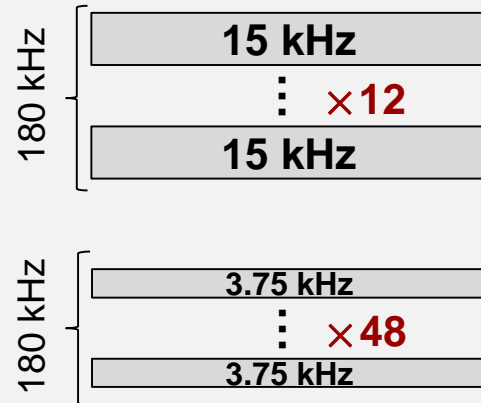

Dense subcarrier spacing

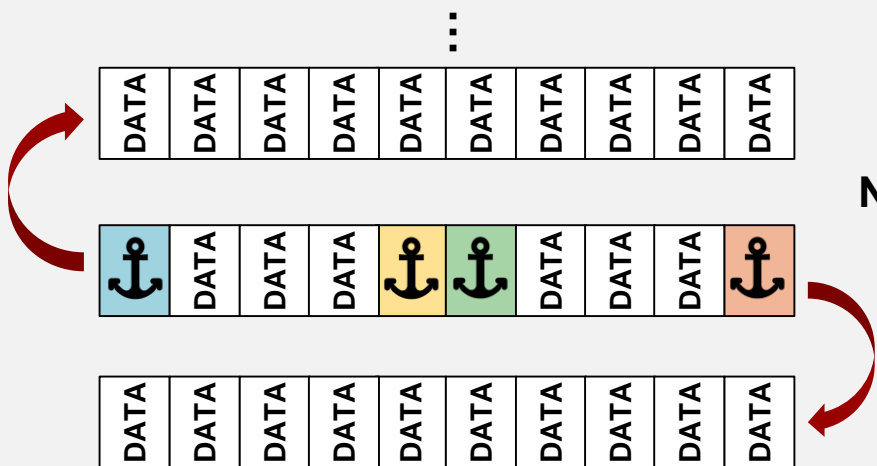

Non-anchor carriers for capacity and load-balancing

eMTC

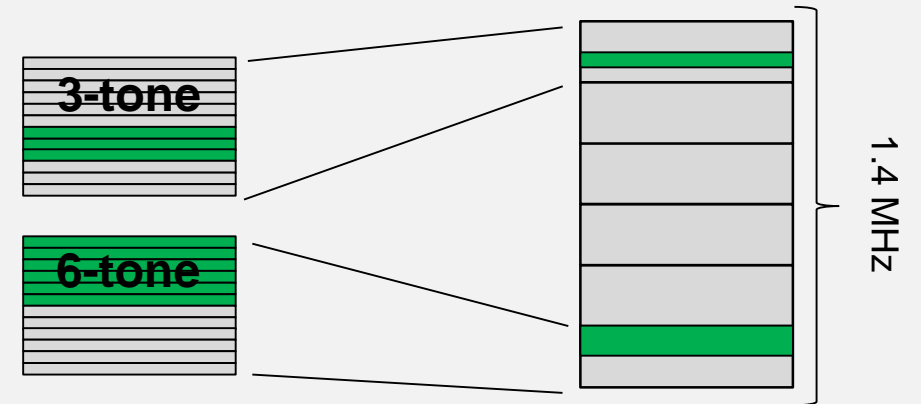

3- and 6-tone allocations within a PRB of a 1.4 MHz narrowband

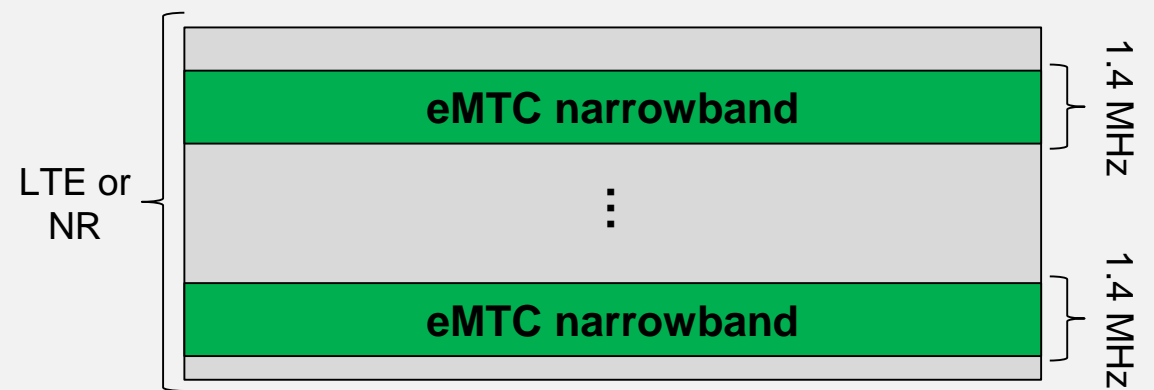

Deploy multiple independent eMTC narrowbands within LTE/NR bandwidth

Ultra-low UE complexity: Signal processing simplifications

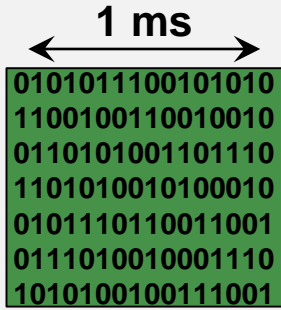

Cat. 1 data

10 000 bits / ms

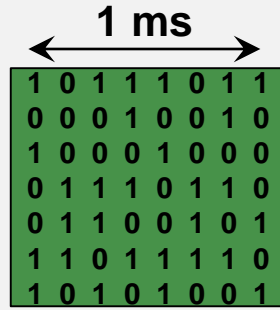

Cat. M1 data

1000 bits / ms

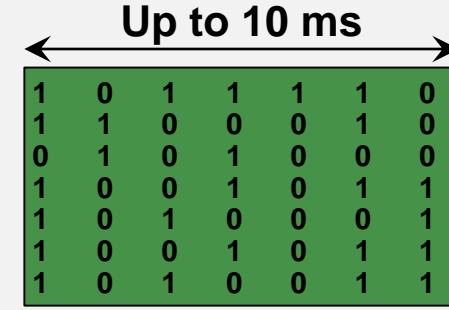

Cat. NB1 data

UL: 1000 bits / up to 10 ms

DL: 680 bits / up to 10 ms

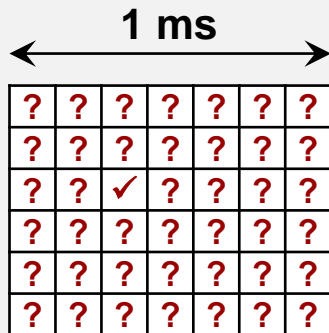
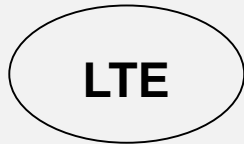

Control channel

~40 candidates / ms

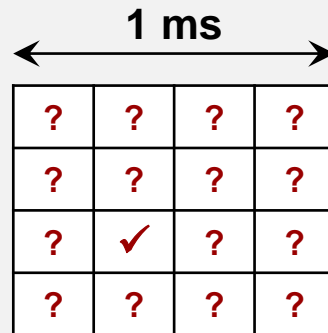
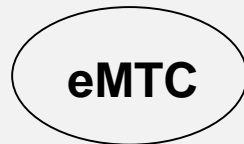

Control channel

~16 candidates / ms

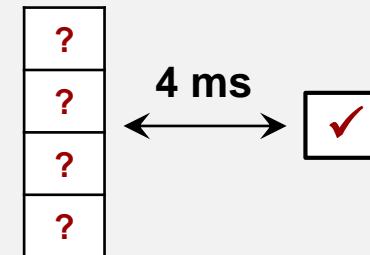

Control channel

~1 candidate / ms

Ultra-low UE complexity: Hardware simplifications

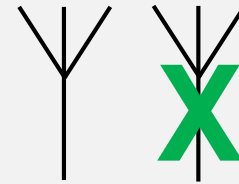
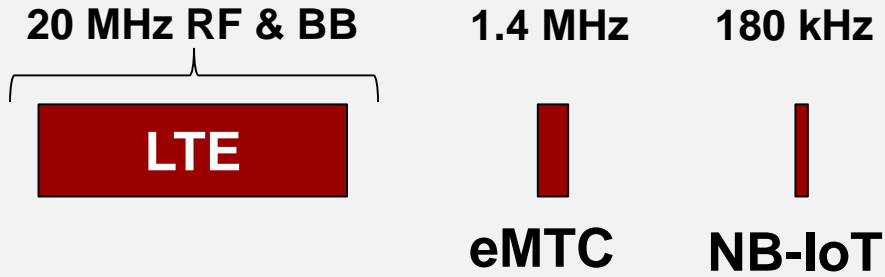

Single receive RF chain for UE

RF bandwidth \Rightarrow RF hardware cost

BB bandwidth \Rightarrow signal processing cost

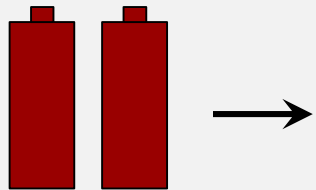

20 dBm and 14 dBm UE transmit power classes

Lower peak current requirement allows cheaper, smaller batteries

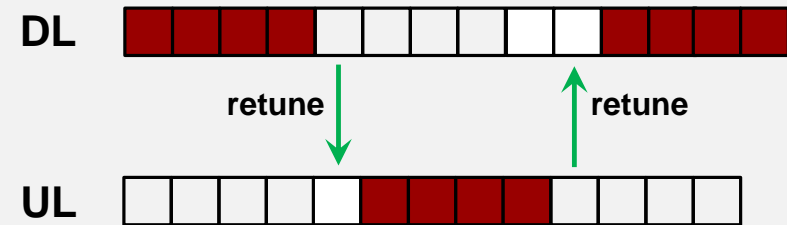

Half-duplex operation allows removal of duplexer from UE
(Mandatory NB-IoT, optional eMTC)

Ultra-low UE complexity: Further steps in NB-IoT

- NB-IoT takes additional steps to allow low-cost hardware:
 - Downlink uses convolutional encoding, removing need for turbo decoder in UE
 - 1 or 2 HARQ processes, instead of 8 in LTE/eMTC, reduces memory for data buffering
 - Synchronization signals with low complexity, optimised for reception in deep coverage
 - Maximum modulation is QPSK instead of 16-QAM, lessening EVM requirements
 - UE is allowed a much longer time to decode a reception before reacting to it, e.g. for DL:

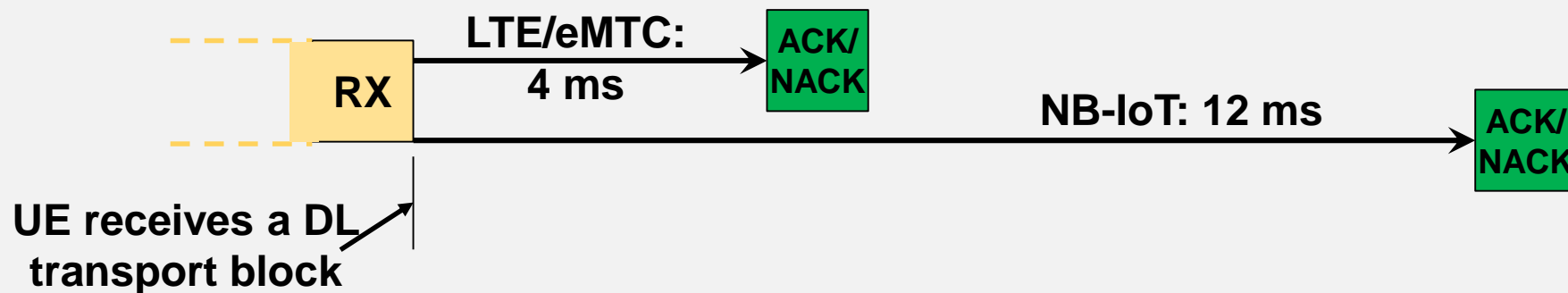

- 40 ms gap after each 256 ms of transmission during UL, allowing UE to re-sync to DL
 - Allows lower-cost non-temperature compensated crystal oscillators to be used in chipsets
 - Mandatory in NB-IoT UEs, optional for eMTC

Coverage extension

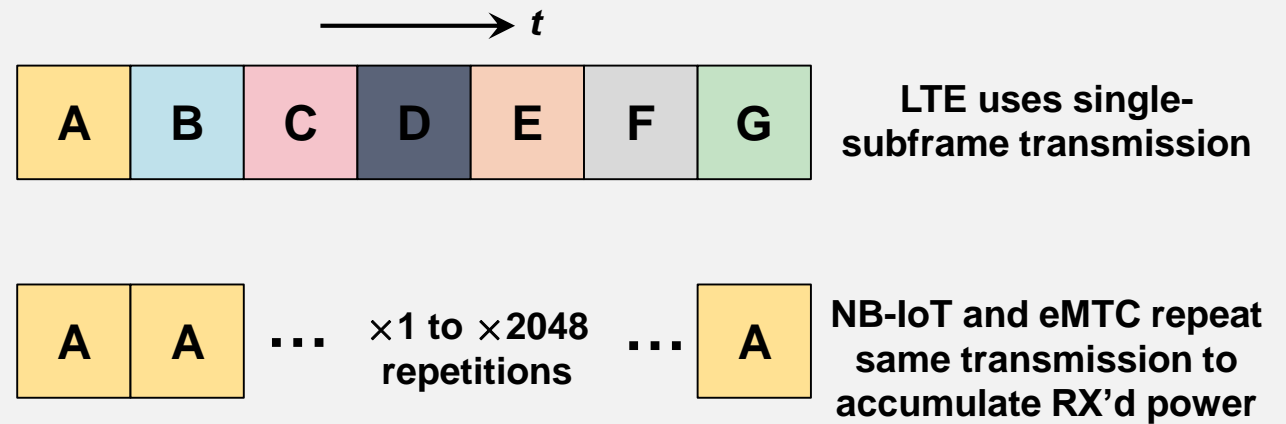
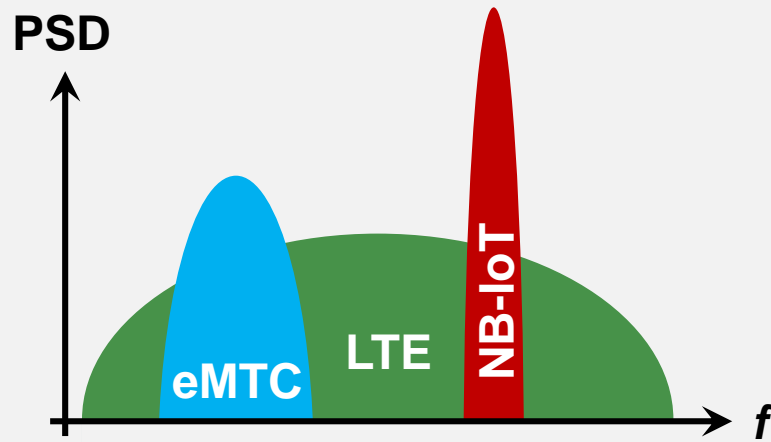

PSD boost in bandwidth as small as 3.75 kHz

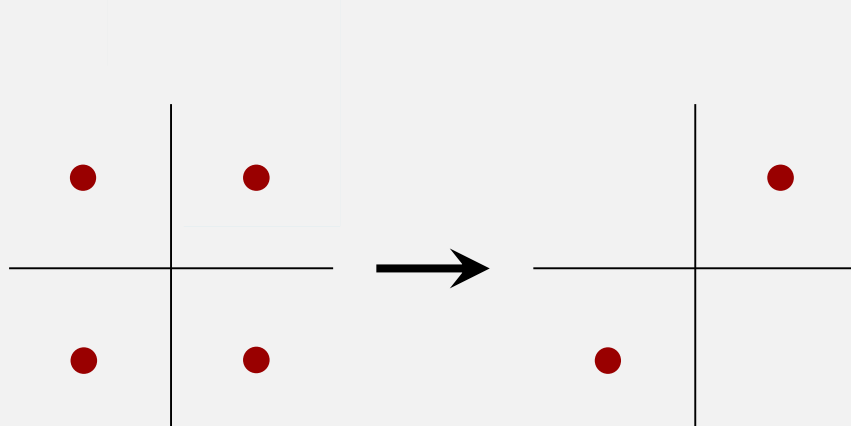

Low-PAPR $\pi/2$ -BPSK modulation
(and $\pi/4$ -QPSK in NB-IoT)

HUAWEI TECHNOLOGIES CO., LTD., Proprietary

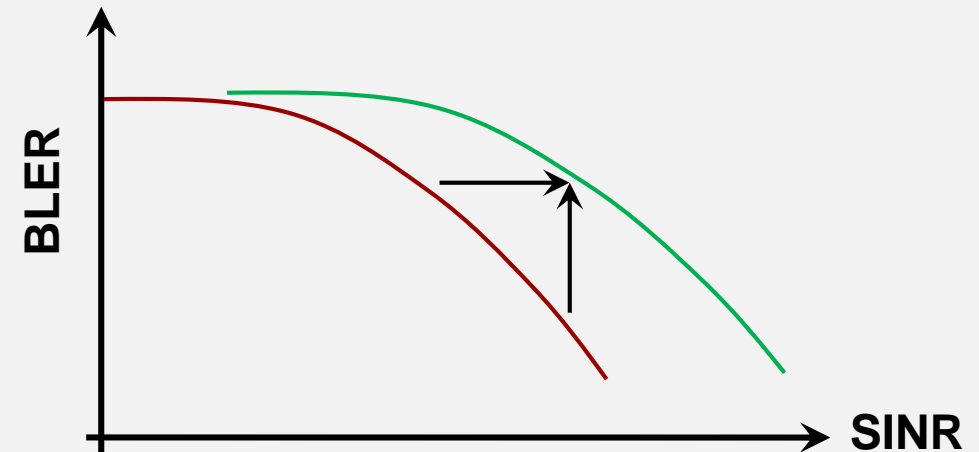

Relaxed requirements to tolerate lower SINR regimes

Battery life 10 – 15 years

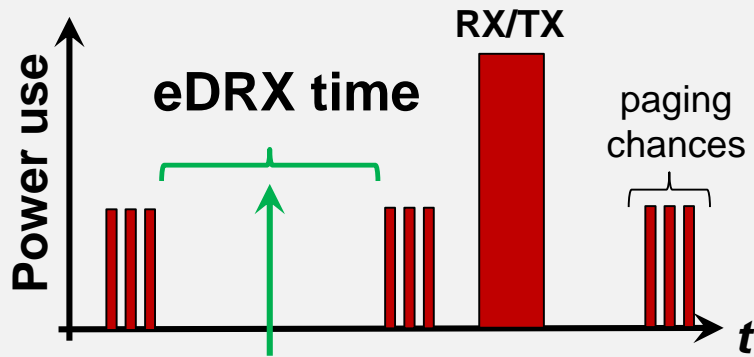

NB-IoT: ≤ 3 hr
eMTC: ≤ 40 min

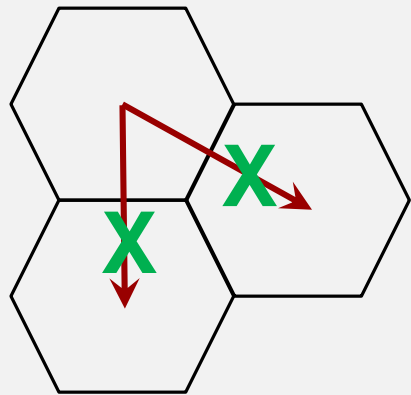
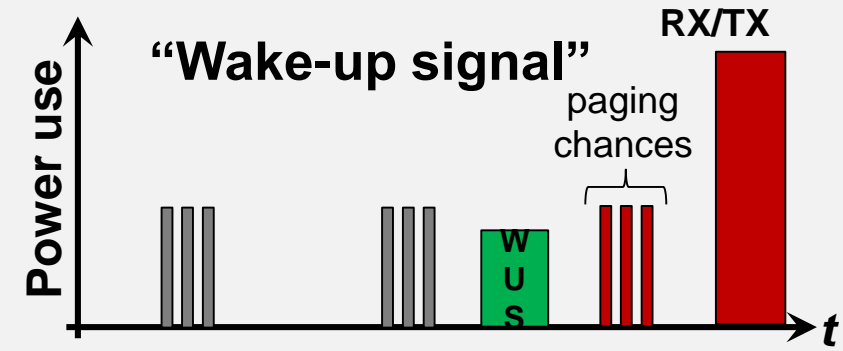
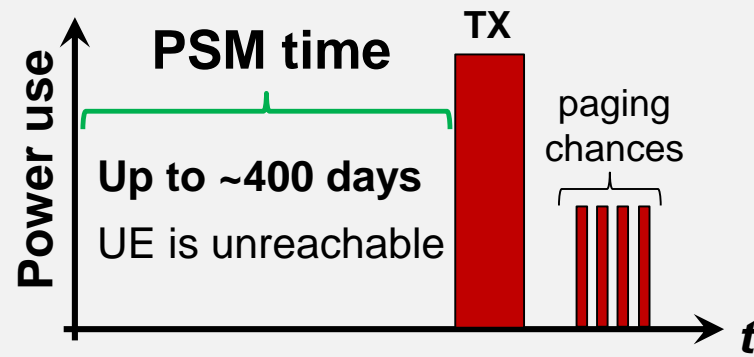

NB-IoT: No handover measurements / signalling

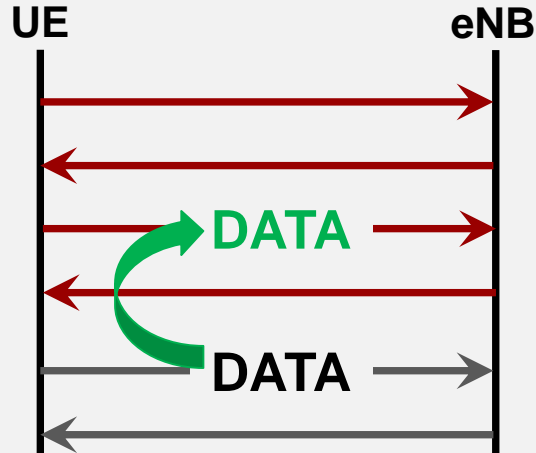

Earlier data transmission, without tx/rx'ing to complete connection

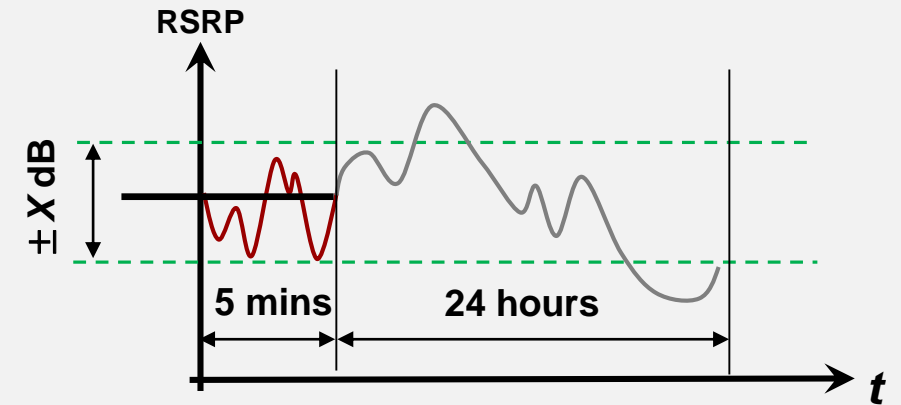

Stationary UE can suspend measurements of neighbour cells

Hallmarks of 3GPP LPWA IoT technologies

Battery life of 15 years or more on 2AA cells (5 Wh)

- Optimised for small infrequent packet transmissions e.g. 50-200 bytes few times/day
 - Transfer data earlier with fewer transmissions, and less battery consumption
- Maximise time UE can spend in low-power states and eliminate avoidable UE RX/TX

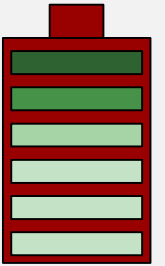

Support for normal to moderate coverage and deep coverage scenarios

- Repetition, PSD boosting, and low-PAPR transmissions
- In good coverage, NB-IoT and eMTC do not need repetitions

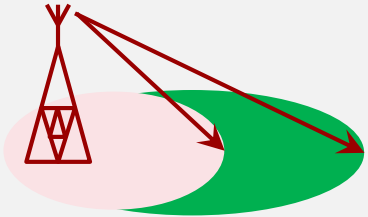

mMTC connection density of $\geq 1\,000\,000$ UE/km²

- Small resource allocations, 3.75 kHz subcarriers (NB-IoT), scalable network capacity
- Reduced signalling overhead to free-up resources for connecting more devices per cell

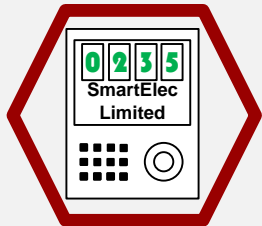

Complexity and cost is much lower than MBB devices

- Reduced RF and baseband bandwidths of 1.4 MHz for eMTC and 180 kHz for NB-IoT
- Relaxed signal processing requirements, with further relaxations in NB-IoT

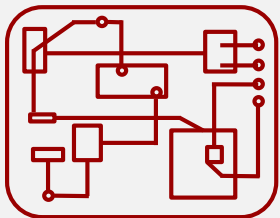

CONTACT
Matthew Webb
matthew.webb@huawei.com

THANK YOU

www.huawei.com

Copyright©2018 Huawei Technologies Co., Ltd. All Rights Reserved.

The information in this document may contain predictive statements including, without limitation, statements regarding the future financial and operating results, future product portfolio, new technology, etc. There are a number of factors that could cause actual results and developments to differ materially from those expressed or implied in the predictive statements. Therefore, such information is provided for reference purpose only and constitutes neither an offer nor an acceptance. Huawei may change the information at any time without notice.

